



Cover 1:
Casper Charcoal

Cover 1:
Norfolk Mustard

Mid Oak Feet

Louis Collection

Colours represented are to be used as a guide only.
Please refer to manufacturers swatch for a more accurate colour match.

Please note that colour shadings can vary slightly from each roll of fabric.
We cannot guarantee a precise match to these samples or between cut lengths and upholstered goods.

Extra Flex[®]
Soft, Supportive Seating

03/11/2020

LOUIS COVER GUIDE: STANDARD BACK & PILLOW BACK

Please use this guide when ordering the following pieces to clarify cover options.

STANDARD BACK

Corner Group: L2, R2C (LH2, R2C)

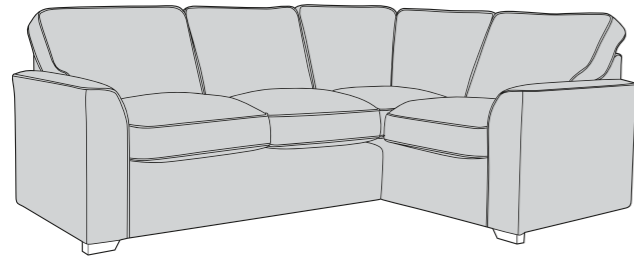

Corner Group: L2C, R2 (L2C, RH2)

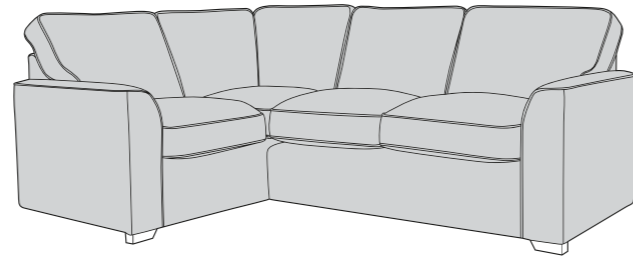

3 Seater Sofa (3ST)

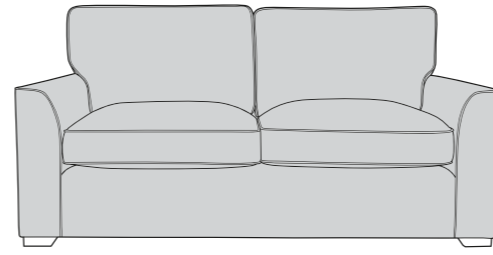

2 Seater Sofa (2ST)

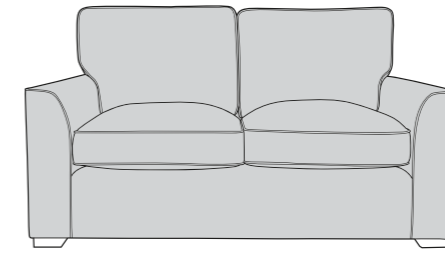

Arm Chair (1ST)

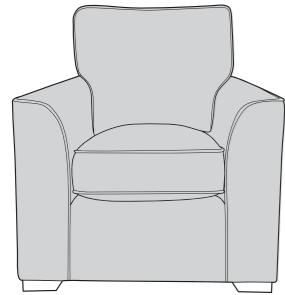

PILLOW BACK

Corner Group: L2, R2C (LH2, R2C)

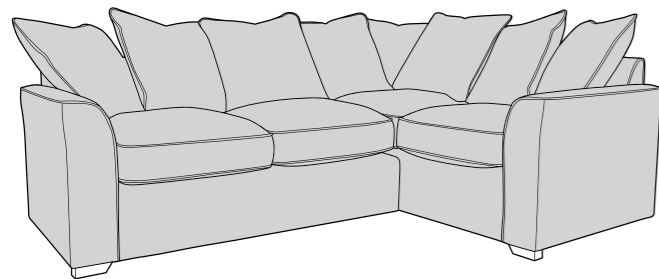

Corner Group: L2C, R2 (L2C, RH2)

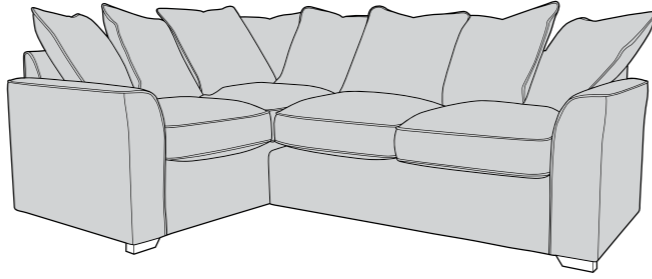

3 Seater Sofa (3ST)

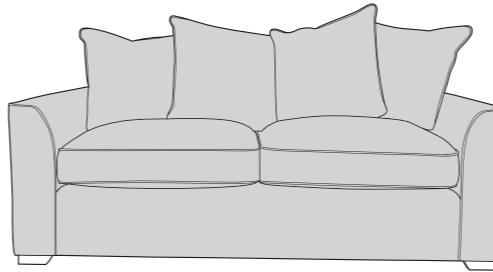

2 Seater Sofa (2ST)

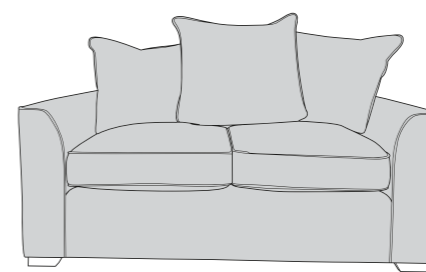

ACCENT PIECES

Louis (York)
Accent Chair (ACH) *

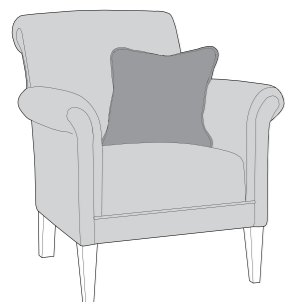

Louis (New Fenton)
Footstool (FST) *

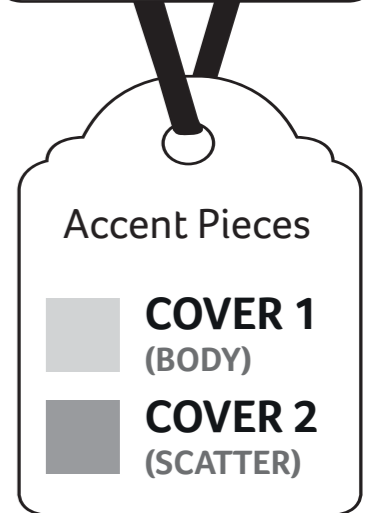
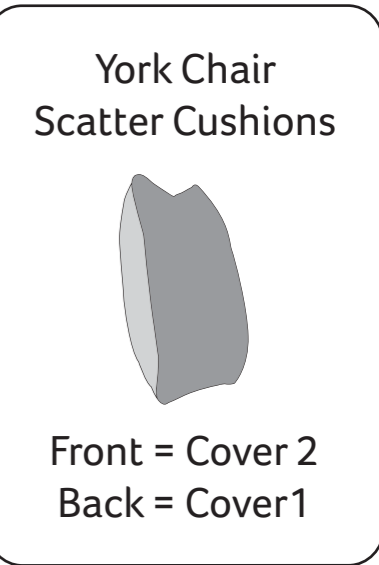
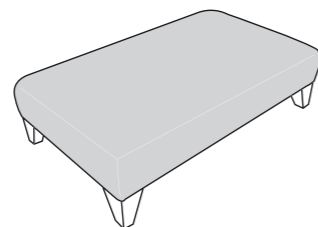

* Chrome feet not available.



APPROVED MEMBER



LOUIS DIMENSIONS (CM)

AVAILABLE PIECES	HEIGHT 1	OUTBACK HEIGHT	WIDTH 2	DEPTH 3	ARM HEIGHT	SEAT HEIGHT 4	SEAT DEPTH (STD) 5	SEAT DEPTH (PIL) 5	SEAT WIDTH 6	ACCESS DIAGONAL 7	WEIGHT (KG)
L2, R2C GROUP or L2C,R2 GROUP	96	78	249	175	65	50	N/A	N/A	N/A	N/A	93
L2/R2 UNIT	96	78	154	95	65	50	55	55	N/A	177	41.5
L2C/R2C UNIT	96	78	175	95	65	50	55	55	N/A	193	51.5
3 SEATER SOFA	96	78	194	95	65	50	55	55	156	208	51.5
2 SEATER SOFA	96	78	168	95	65	50	55	55	128	184	47
ARM CHAIR	96	78	88	95	65	50	55	55	49	120	31
ACCENT PIECES											
LOUIS ACCENT CHAIR	85	N/A	76	81	N/A	45	50	N/A	48	N/A	19.5
LOUIS FOOTSTOOL	35	N/A	106	65	N/A	N/A	N/A	N/A	N/A	75	14.5



- * Hardwood & composite board frame.
- * Dowelled, screwed, glued & stapled joinery.
- * Chrome & Wood foot options.

- * ExtraFlex high comfort seat cushions.
- * Fibre Filled backs for added comfort..

- * Serpentine seat springs & silent wire.
- * Elasticated back webbing.

DIMENSION GUIDE

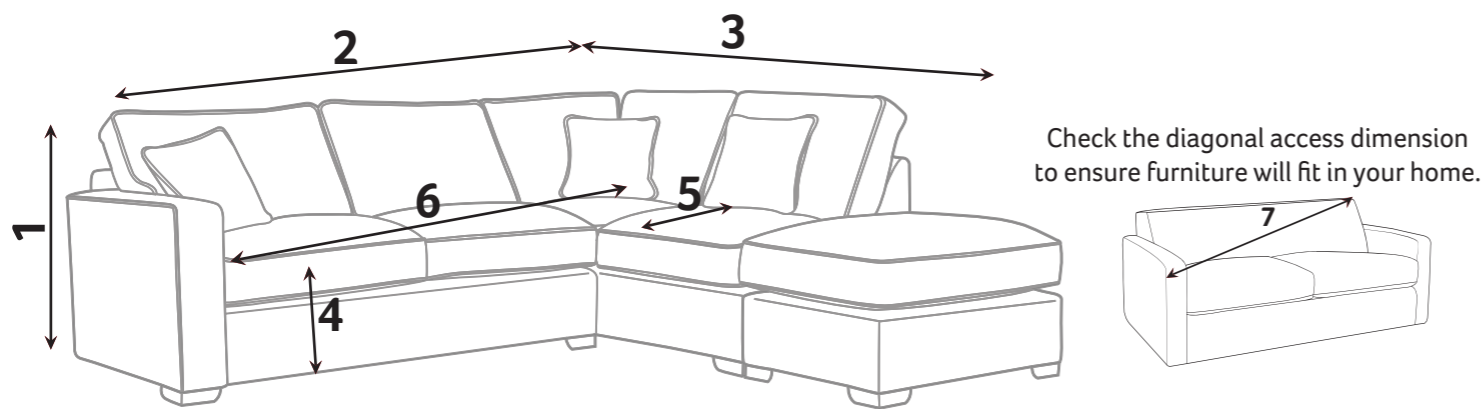

- 1 - HEIGHT
- 2 - WIDTH
- 3 - DEPTH
- 4 - SEAT HEIGHT
- 5 - SEAT DEPTH (STD & PILLOW)
- 6 - SEAT WIDTH
- 7 - DIAGONAL ACCESS

Illustrations used for reference only.

Extra Flex®

A high density foam base seat interior with a hand-rolled carded fibre, channelled topper which provides both softness and support.

CARE GUIDE

Extraflex seat cushions should be plumped up on a regular basis to help maintain the aesthetical appeal of your upholstery, the plumping of cushions is essential to help retain the comfort and softness of any piece of upholstered furniture.

To improve the longevity of your hand-made furniture, we recommend rotating cushions (where applicable).

For further information on maintaining your furniture please refer to the care guide located under the seat platform.

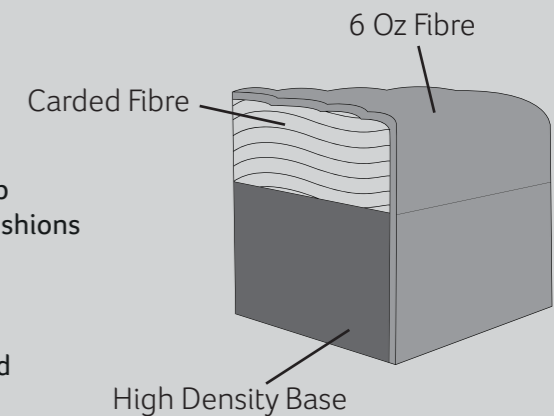

Mid Oak (light) Antique (dark) Chrome

FOOT OPTIONS:



Wood is a natural product and will vary in shade/colour from item to item. Feet may require fitting.

Please note : All dimensions are approximate. Allow tolerance of +/- 2.5cm.

